



The Power to Surprise

Emergency Rescue Guide Manual



NIRO

Introduction	1
Document Purpose	1
Vehicle Description	2
Niro Identification	3
General Vehicle Description	3
Identifying a Kia Niro	3
Niro Main Electronic Systems	6
Power Electronics Specification	6
Vehicle Components	7
Airbag system (SRS: Supplemental Restraint System).	10
Emergency Procedures	12
Initial Response: Identify, Immobilize and Disable.	12
Extraction Operations.	18
NO-CUT ZONES.	19
Vehicle Fire	20
Submerged or Partially Submerged Vehicles.	20
High Voltage Battery Damage and Fluid Leaks	22
Roadside Assistance	23
Towing.	23
Emergency Starting.	24

Document Purpose

The purpose of this document is to familiarize first responders and the towing/roadside assistance industry with the proper methods to handle the Niro in an emergency situation. This guide gives a basic overview of key vehicle systems and instructions for dealing with the different types of emergencies encountered by first responders. The emergency response procedures for this vehicle will provide how to deal with the high voltage electrical system.

Within this Emergency Response Guide you will find *Notices, Cautions, Warnings* and *Dangers* which provide critical information and help you do your job safely and efficiently. Below are the definitions of these terms. When you see a *Notice, Caution, Warning* or *Danger*, be certain you understand the message before you attempt to perform any part of an emergency response procedure.

DANGER

A Danger alerts you to a hazardous situation which, if not avoided will result in death or serious injury.

WARNING

A Warning alerts you to a hazardous situation which, if not avoided, could result in death or serious injury.

CAUTION

A Caution alerts you to a hazardous situation which, if not avoided, could result in minor or moderate injury.

NOTICE

A Notice alerts you to a situation which, if not avoided, could result in vehicle damage.

Vehicle Description

As with other HEV, the Kia Niro uses the combination of a conventional gasoline powered internal combustion engine and a high voltage electric motor to propel the vehicle. This combination provides for improved gas mileage over a conventional Kia as well as an increase in power over the standard 4-cylinder engine. The high voltage electrical system is completely self-contained and does not need to be recharged by an external power source such as a charging station. The high voltage battery is recharged automatically while driving the vehicle. This is accomplished through the use of a generator that produces electricity while driving and braking.



Identifying a Kia Niro

"Eco Hybrid" logo on tail gate

The Kia Niro can be easily identified by the "Eco Hybrid" logo attached on the tail gate.

⚠ DANGER Electrocutation Risk

The hybrid logo can become hidden after a crash due to damage to the vehicle. Always be sure to utilize additional methods of identification before determining the vehicle is not a hybrid.



Engine Room

A "Hybrid" badge is also displayed under the hood on the engine cover. Also, the High Voltage cabling is orange per SAE standard. Cables run from the bottom of the vehicle where they connect the High Voltage Battery to the HPCU (Hybrid Power Control Unit), Motor, Inverter, and other High Voltage components at the front of the vehicle.

The presence of orange cables under the hood identifies the vehicle as an HEV.



VIN Label

The VIN (Vehicle Identification Number) identifies the Hybrid with a "C" displayed in the 8th position, as shown in the below drawing.

The VIN can be found:

- 1) Underneath the front passenger seat (or driver seat).
- 2) On the vehicle certification label attached to the driver's side (or passenger) center pillar.

XXXXXXXXCXXXXXXXXXX

8th position

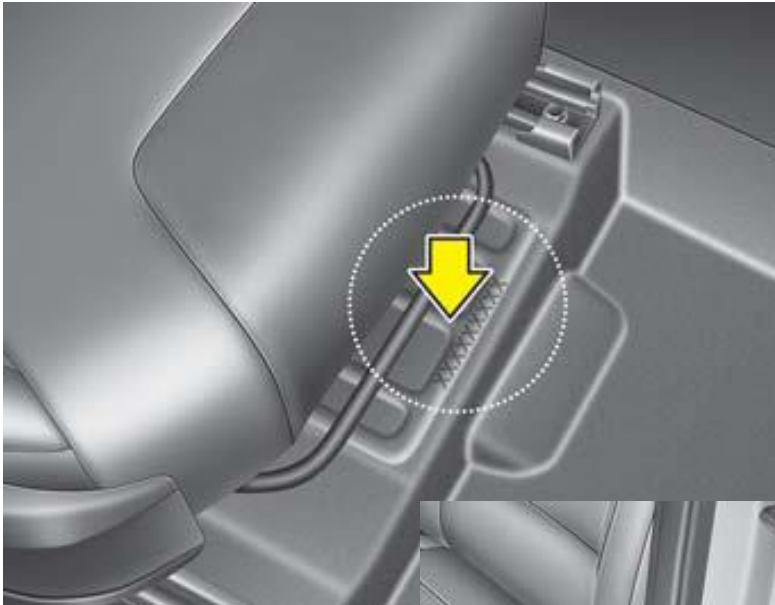

Niro Cluster Instrument Panel

The Niro Cluster Instrument Panel displays the HEV specific features such as high voltage battery SOC (State of Charge) in the highlighted part.

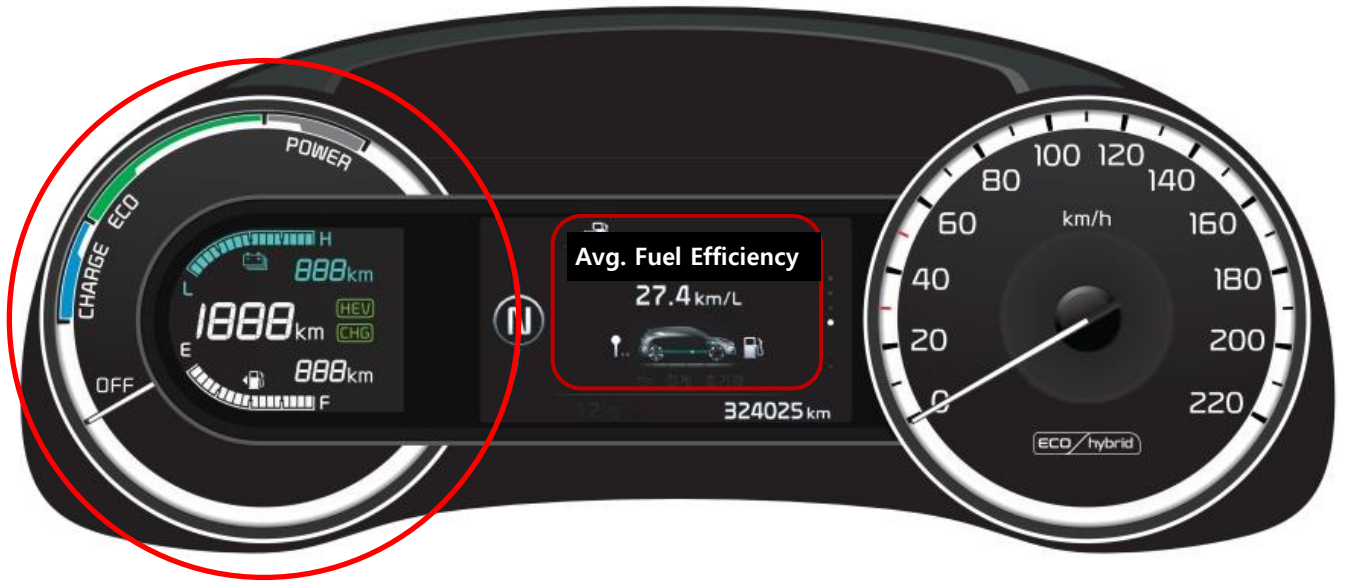

High Voltage System

Hybrid
Starter
Generator (HSG)

Motor

Transmission

12V battery ground

High-voltage battery

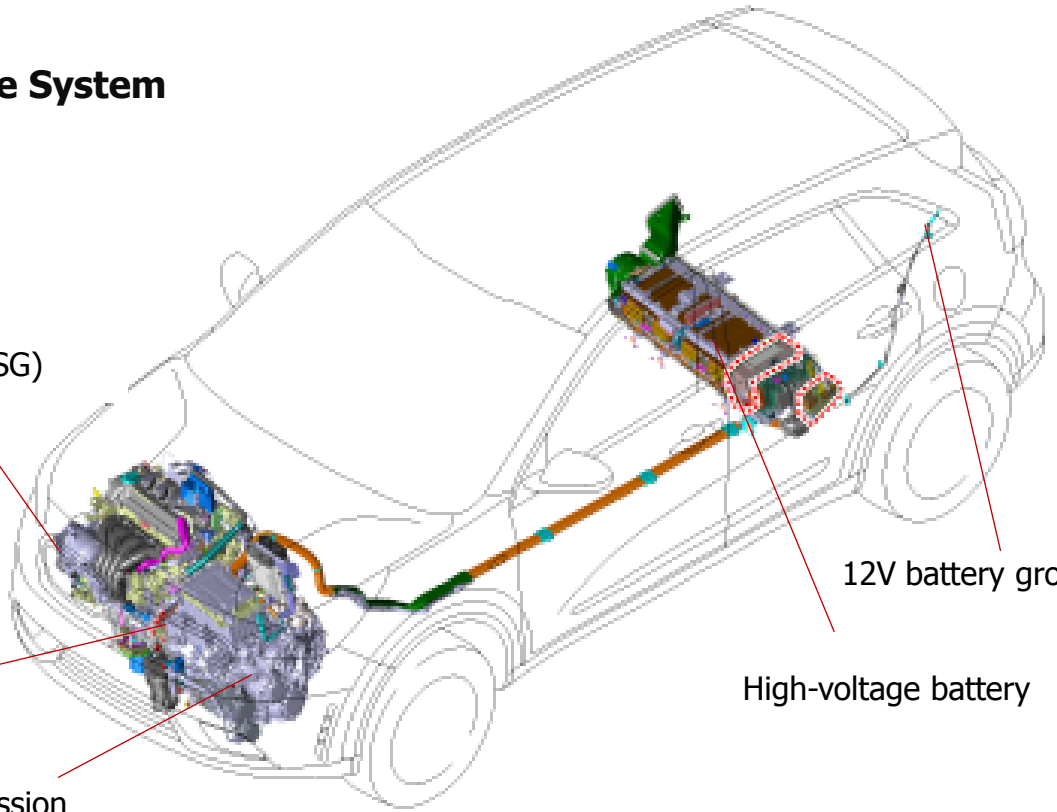

Motor		Type	Permanent magnet synchronous motor
		Max. Output HP(kW)	43 (32)
		Max Torque lb-ft(Nm)	125 (170)
HPCU	Inverter	Input Voltage(V)	200 ~ 310
	LDC	Max. Output HP(kW)	2.4 (1.8)
High Voltage Battery		Type	Lithium-ion polymer
		Rated Voltage (V)	240
		Capacity (Ah) / Energy (kWh)	6.5 / 1.56
		Quantity for Pack (Cell / Module)	64Cells / 4Modules

Vehicle components

12V auxiliary battery

The 12V auxiliary battery is unified with high voltage battery, which is located under the rear seat, and powers all of the vehicle's standard electronics like radio, air conditioner, etc. Also, it powers the HPCU (Hybrid Power Control Unit) which controls high voltage current to main electronic systems like the motor.

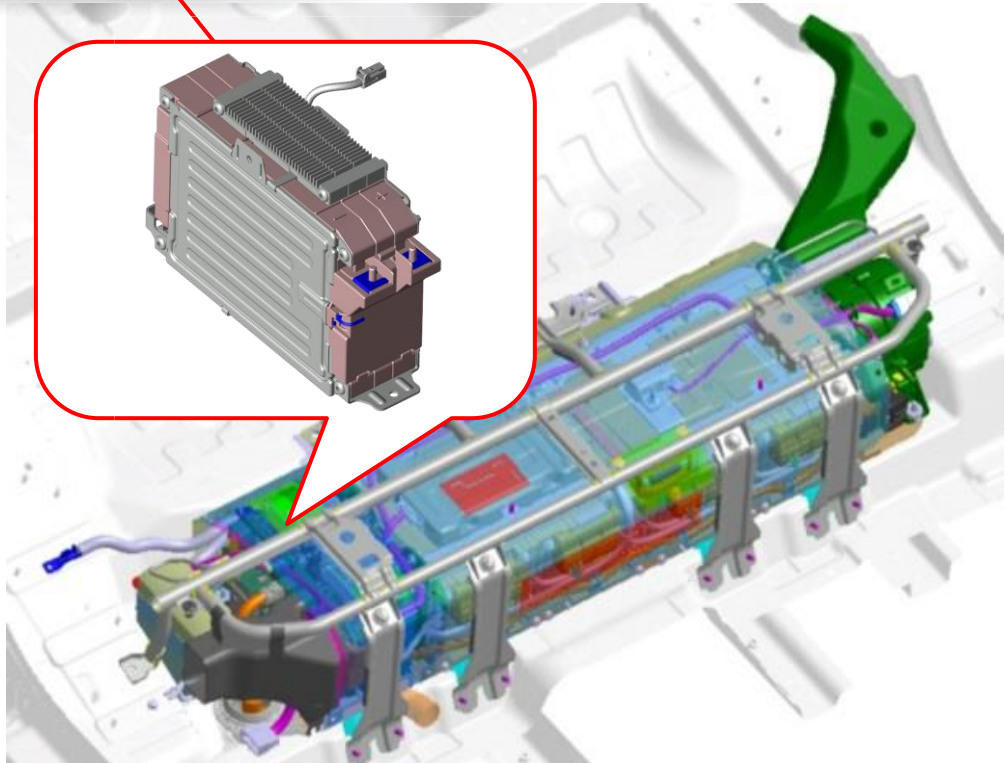

Motor

The motor of the HEV converts electrical energy into motive force with a Max. power of 43Hp (32kW) and Max. torque of 125lb-ft (170Nm).

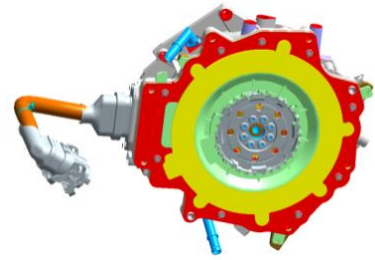

Hybrid Power Control Unit (HPCU)

The HPCU includes an Inverter and LDC (Low Power DC-DC Converter) in one housing. The inverter converts DC to AC to supply electricity to the motor. It also converts AC to DC to charge the high voltage battery. The LDC transfers high voltage electricity to 12V voltage to charge 12V auxiliary battery.

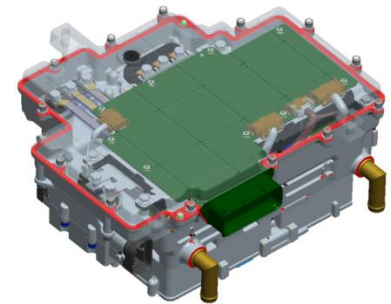

Integrated Battery System (High voltage and Low voltage)

The high voltage battery is integrated with the low voltage battery. High voltage modules supply and store electric energy to traction motor and it is a Lithium ion polymer battery with specifications, 240V / 6.5Ah / 1.56kWh. It is located in the under the rear seat of the Niro.

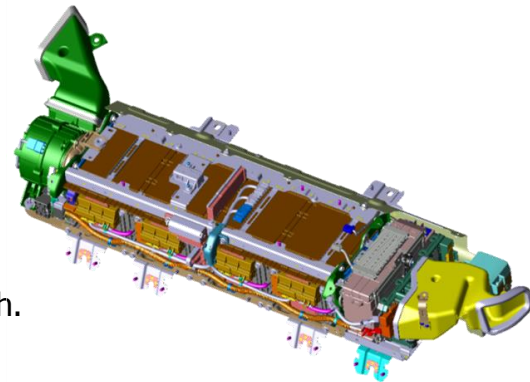

Hybrid Starter Generator (HSG)

The HSG restarts the engine at HEV mode and also charges the high voltage battery while driving, that is generator for hybrid vehicle.

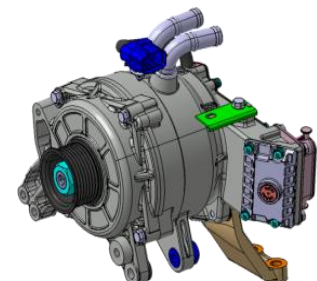

High Voltage Orange Cabling

The High Voltage cabling is orange, per SAE standards. Cables run under the floor of the vehicle and connect the High Voltage Battery to the HPCU, Motor, LDC, Inverter and other High Voltage components at the front of the vehicle.

The presence of orange cables under the hood, on the under-floor battery compartment, or orange shielding under the car, identifies the vehicle as a HEV.

DANGER High Voltage Cables

- *Never cut or disconnect the high voltage orange cabling and connectors without first disabling the system by removing the safety plug (located under rear seat-passenger side).*
- *Exposed cables or wires may be visible inside or outside the vehicle. Never touch the wires, cables, connectors, or any electric components before disabling the system, to prevent injury or death due to electrical shock.*

Failure to follow these instructions can lead to death by electrical shock.

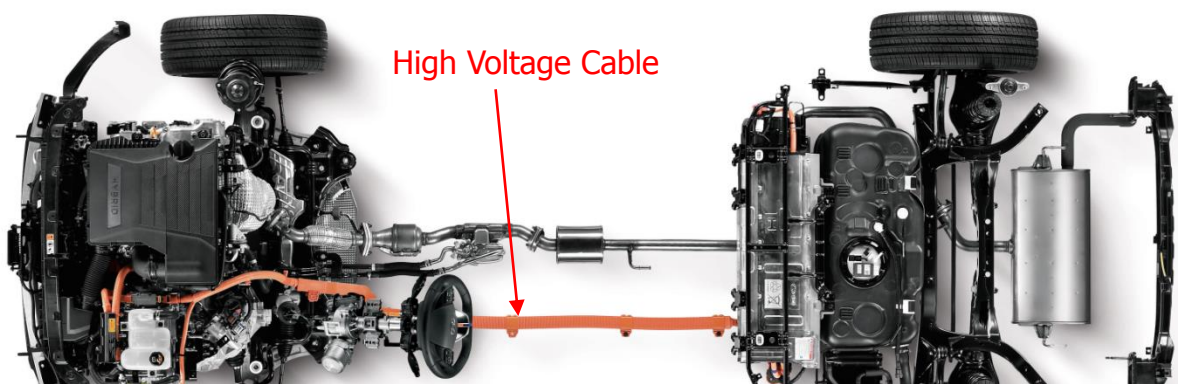

Airbag system (SRS: Supplemental Restraint System)

Airbag

Seven airbags are installed in the Niro, located in standard area of the vehicle so that the first responder can find them immediately. Before emergency procedure, make sure the vehicle ignition switch is turned off, disconnect the negative connector from the 12V auxiliary battery (located behind the rear passenger seat-drivers side) to prevent accidental deployment of undeployed airbags.

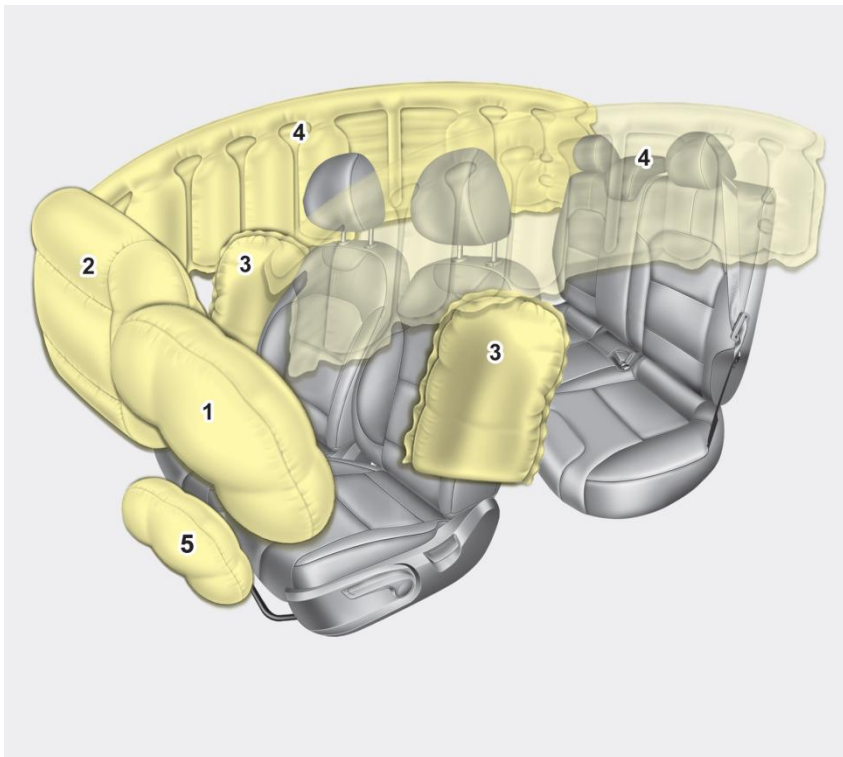

- (1) Driver front airbag
- (2) Passenger front airbag
- (3) Side airbag
- (4) Curtain airbag
- (5) Driver's knee air bag

* The actual air bags and seats in the vehicle may differ from the illustration.

Seat Belt Pretensioner

The Niro is equipped with driver's and front passenger's seat belts with pretensioners. When the seat belt pretensioners are activated in a collision, a loud noise may be heard and fine dust, which may appear to be smoke, may be visible in the passenger compartment. These are normal operating conditions and are not hazardous. The seat belt pretensioner assembly mechanisms may become hot during activation, and may need several minutes to cool after they have been activated.

Airbag system components

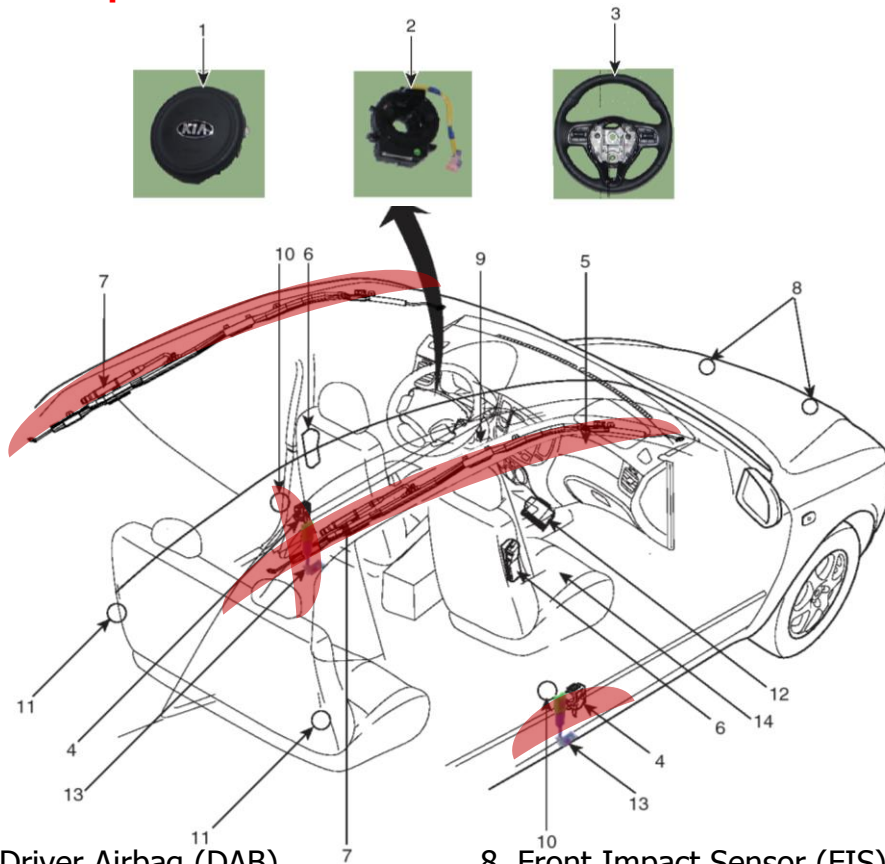

- | | |
|---------------------------------|--|
| 1. Driver Airbag (DAB) | 8. Front Impact Sensor (FIS) |
| 2. Clock Spring | 9. Knee Airbag (KAB) |
| 3. Steering Wheel | 10. Pressure Side Impact Sensor (PSIS) |
| 4. Seat Belt Pretensioner (BPT) | 11. Rear Side Impact Sensor (RSIS) |
| 5. Passenger Airbag (PAB) | 12. Supplemental Restraint System Control Module (SRSCM) |
| 6. Side Airbag (SAB) | 13. Emergency Fastening Device (EFD) |
| 7. Curtain Airbag (CAB) | 14. Occupant Classification System (OCS) |

⚠ WARNING Undeployed Airbags

To avoid injuries caused by accidental deployment of undeployed airbags

- *Do not cut the red colored part on the above layout.*
- *Make sure the vehicle ignition switch is turned off, disconnect the negative cable from the 12V auxiliary battery (located behind the rear passenger seat-drivers side), and wait 3 minutes or longer to allow the system to deactivate.*

Failure to follow any of these instructions may result in serious injury or death from accidental deployment of the airbag system.

Initial Response: Identify, Immobilize and Disable

The following procedures should be used whenever you are dealing with a Niro at an emergency scene. All other operations should be consistent with your department's standard operating procedures or guides. When a Hybrid is damaged in a crash, the high voltage safety systems may have compromised and present a potential high voltage electrical shock hazard. Exercise caution and wear appropriate personal protective equipment (PPE) safety gear, including high voltage safety gloves and boots. Remove all metallic jewelry, including watches and rings.

Identify

The Niro is an Eco-electric vehicle. Emergency responders should respond to emergency scenarios involving the Niro accordingly being careful to avoid contact with the high voltage system within the vehicle.



Immobilize

The next step is to immobilize the vehicle to prevent any accidental movement that can endanger response personnel and civilians alike. Although Niro emits virtual sound of engine, if it is damaged in a crash, there may be instances where the vehicle appears to be shut of when it is not due to no engine sound.

When in  "READY" mode the lamp is illuminated on the Instrument Panel, the vehicle can move almost silently using the electric motor. Responders should approach the vehicle from the sides and stay away from the front or rear as they are potential paths of travel. Immobilizing the vehicle in the following procedure.

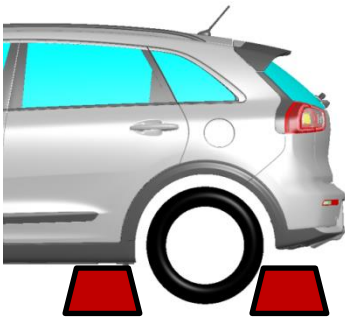

Chock the wheels



Set the parking brake.



Position the shift lever in park (P)

Disable

The final step in the initial response process, conducted after immobilizing the vehicle, is to disable the vehicle, its SRS components and the high voltage electrical system. To prevent current flow through the system, use one of the following procedures to disable the vehicle.

I . Disabling the System – Smart Key System and “POWER” START/STOP Button

1. Confirm the status of the READY light on the instrument panel. If the  READY light is illuminated, the vehicle is on.

a) If the READY light is NOT illuminated, the vehicle is off. Do not push the “POWER” START/STOP button because the vehicle may start.



“POWER” START/STOP Button

b) To turn off the system, put the shift lever in the P (Park) position and press the POWER button.

Without depressing the brake pedal

Pressing POWER button	POWER button LED color	Vehicle condition
	Off	Off
One time	Amber	Electrical accessories are operational.
Two times	Reddish orange	The warning lights can be checked before the vehicle is started.
Three times	Off	Off

While depressing the brake pedal while a shift lever is in the P (Park) position

Pressing POWER button	POWER button LED color	Vehicle condition
	Off	Off
One time	Off	Ready to drive

2. If necessary, lower the windows, unlock the doors and open the tail gate as required, before disconnecting the 12V battery. Once the 12V battery is disconnected, power controls will not operate.

3. Before disconnecting 12V battery, remove the Smart Key at least 2 meters away from the vehicle to prevent accidental restart.

4. Use the following procedure to remove the safety plug and disable the high voltage battery:

- a) Open tail gate and remove the luggage side cover (A).
- b) Disconnect the battery negative connector (A).

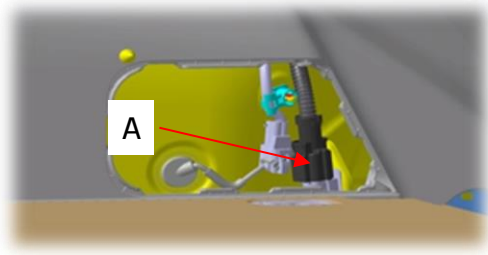
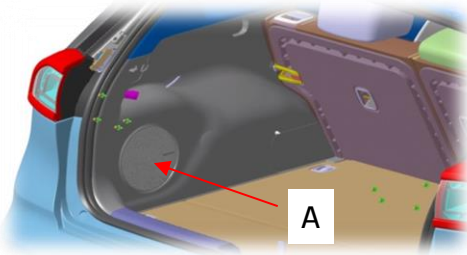

- c) Remove the safety plug cover (A) under the rear seat.



- d) Unfasten the hook (A) to the direction of arrow.



- e) Unfasten the lever (A) to the direction of arrow.



- f) Remove the safety plug (A).



II. Disabling the System – IG (Ignition) Fuse Removal

1. Open the hood.
2. Remove the engine room fuse box cover.
3. If necessary, lower the windows, unlock the doors and open the tail gate as required, before disconnecting the 12V battery (located behind the rear passenger seat-drivers side). Once the 12V battery is disconnected, power controls will not operate.



Engine room fuse box

4. In the event the vehicle may not be disabled using the “Power” START/STOP Button, pull the IG1, IG2 Fuse from the engine room fuse box. If the IG Relay cannot be located, pull out all the fuses and relays in the fuse box.

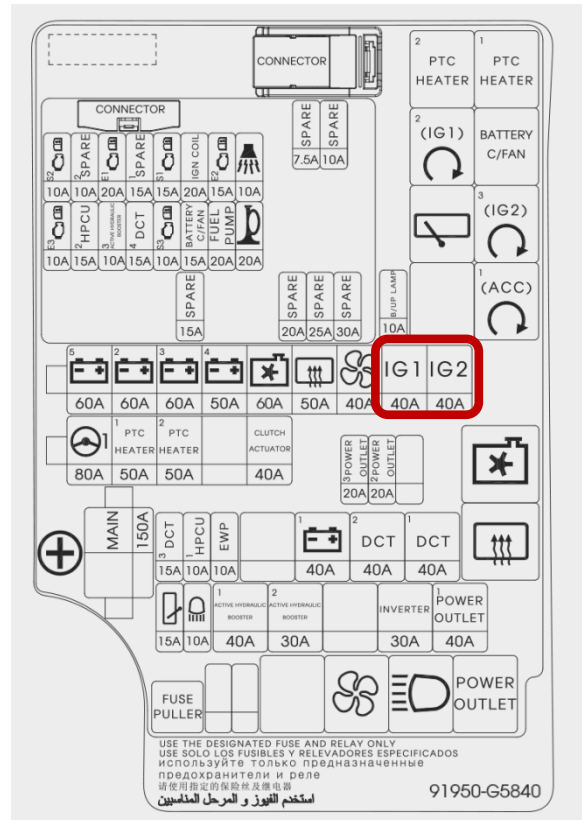

5. Remove the safety plug and disable the high voltage battery
(Refer to No.5 procedure in page 15)

If previously mentioned methods of disabling system are unsuccessful, the vehicle is not secured from accidental deployment of undeployed airbags and electric shock of high-voltage components.

⚠ DANGER Electrocutation Risk

- *Before engaging in emergency response procedures, ensure the vehicle is disabled and wait 5 minutes to allow the capacitor in the high voltage system to discharge to avoid electrocution.*
- *Exposed cables or wires may be visible inside or outside the vehicle. Never touch the wires or cables before disabling the system, to prevent injury or death due to electrical shock.*

Failure to follow these instructions can lead to death by electrocution.

Extraction Operations

The Niro is an Eco-electric model (HEV/PHEV). Because of the high voltage components contained therein, first responders should pay special attention when they extract occupants in the car. Before extraction operations, the first responders should "Identify, Immobilize and Disable" the vehicle as discussed in sections on page 12-17.

Vehicle Stabilization

Use standard stabilization (cribbing) points, as shown beside. Always be sure to connect to a structural member of the vehicle and avoid placing cribbing under high voltage cables, fuel lines and other areas not normally considered acceptable.

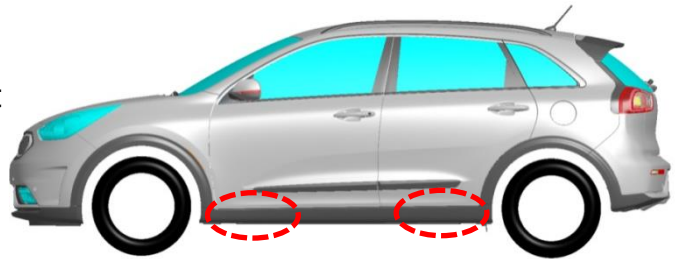

Extraction tools and procedure

When responding to an incident involving a Niro, we recommend that the first responders follow their organization's standard operating procedures for assessing and dealing with vehicle emergencies.

When the first responders cut the vehicle, they should always pay special attention to the airbag system, orange colored high voltage cables and other high voltage components so that the parts are not damaged, causing risks of explosion.

Location of ultra-high strength steel

In the image, high strength steel is used in the areas colored in blue and ultra-high strength steel is used in the red colored areas. Depending on the tools used, ultra high strength steel can be challenging or impossible to cut. If necessary, use a workaround technique.

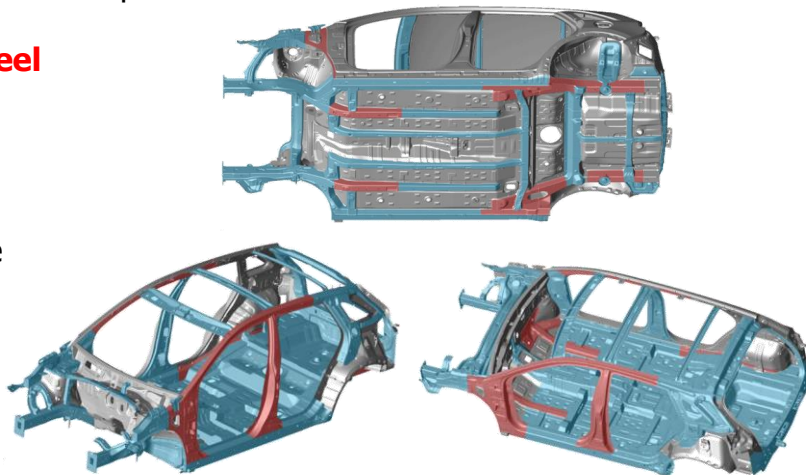

- Mild steel
- High strength steel
- Ultra-high strength steel









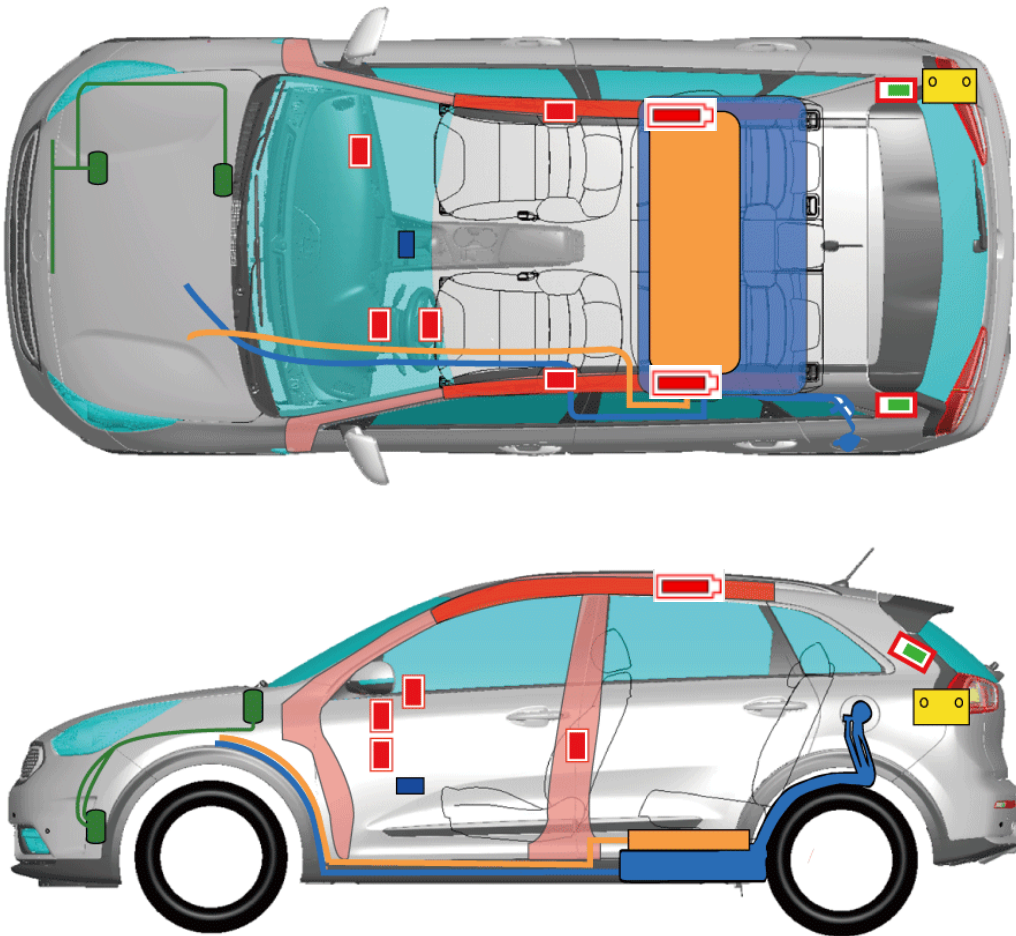

NO-CUT ZONES

The areas highlighted in yellow indicate "no-cut zones" that must not be cut during emergency procedures due to high voltage, gas inflators and airbag hazards.

⚠ DANGER

Do not attempt to enter the vehicle by cutting through the "no-cut zones" identified in the image below. Cutting through these zones can result in death by explosion or electrocution.



- | | | | | | |
|---|--|--|---------------------------|--|---------------|
|  | Airbag&Gas inflators |  | Airbag |  | Gas inflators |
|  | Supplemental Restraint System Control Module (SRSCM) |  | Ultra-high strength steel |  | 12V Battery |
|  | High voltage battery & cable |  | Fuel system | | |
|  | Refrigerant gas pipe |  | Gas Lifter | | |

Vehicle Fire

After Initial Emergency Response Procedures have been applied, Firefighting Procedures may begin. Kia recommends that each response team follow their own department's standard operating procedures for fighting vehicle fires in combination with the Niro HEV specific details that are covered in this section.

Firefighting Operations

If the high-voltage battery pack is either involved in or at risk of being involved in a fire in a Niro HEV, strict cautions must be taken while conducting firefighting operations due to following reasons:

- Lithium-ion Polymer batteries contain gel electrolyte that can vent, ignite, and produce sparks when subjected to temperatures above 300°F.
- May burn rapidly with a flare-burning effect.
- Even after the high-voltage battery fire appears to have been extinguished, renewed or delayed fire can occur.
 - Use a thermal imaging camera to ensure the high voltage battery is completely cooled before leaving the incident.
 - Always advise second responders that there is a risk of the battery re-igniting.
 - Fire, submersion or a collision that has compromised the high voltage battery, always store it in an open area with no exposures within 50 feet.
- A burning battery could release hydrogen fluoride, carbon monoxide, and carbon dioxide gasses. Use NIOSH/MSHA approved full-face self-contained breathing apparatus (SCBA) with full protective gear. Even if the high-voltage battery pack is not directly involved in a vehicle fire, approach the vehicle very carefully.

Even if the high-voltage battery pack is not directly involved in a vehicle fire, approach the vehicle very carefully.

Extinguishers

- Small fires that do not involve the high voltage battery should be extinguished using an ABC fire extinguisher for an electrical fire.
- Do not attempt to extinguish fires that involve the high voltage battery with small amounts of water as this can result in electrocution. Fires that involve the high voltage battery should be extinguished using large amounts of water to cool the high voltage battery. Fire fights should not hesitate to pour larger amounts of water on the vehicle in such scenarios.

Submerged or Partially Submerged Vehicles

Some emergency responses can involve a submerged vehicle. Niro HEV that is submerged does not have high-voltage component on the vehicle's body or framework. It is safe to touch the vehicle's body or framework if there is no severe damage to the vehicle, whether it is in water or on land.

In the event of the vehicle is submerged or partially submerged, remove the vehicle from the water before attempting to disable the vehicle. Drain the water from the vehicle. Use one of the methods described in page 14-19 to disable the vehicle.

WARNING

- *If severe damage causes high voltage components to become exposed, responders should take appropriate precautions and wear appropriate insulated personal protective equipment.*
- *Do not attempt to remove a safety plug while the vehicle is in water.*

Failure to follow these instructions can lead to death or serious injury by electrocution.

High Voltage Battery Damage and Fluid Leaks

If electrolyte solution leakage, or damage such as any problem with the Lithium ion battery casing are observed, the first responders should attempt to neutralize the battery by applying a large volume of water to the battery pack while wearing appropriate Personal Protective Equipment (PPE). The neutralization process helps stabilize the thermal condition of the battery pack but does not discharge the battery.

- Cease all smoke, spark, flame around the vehicle.
- Electrolyte solution is a skin irritant.
- Do not touch or step on the spilled electrolyte.
- If electrolyte leak occurs, wear appropriate solvent resistant PPE and use soil, sand, or a dry cloth to clean up the spilled electrolyte. Be sure to adequately ventilate the area.

WARNING Electrolyte Irritation

The high voltage battery contains electrolyte solution. To avoid exposure to electrolyte solution and serious personal injury, always wear appropriate solvent resistant PPE (Personal Protective Equipment) and SCBA (Self-Contained Breathing Apparatus).

- *Electrolyte solution is an eye irritant – In the event of contact with eyes, rinse with plenty of water for 15 minutes.*
- *Electrolyte solution is a skin irritant. Therefore, in the event of contact with skin, wash off with a soap.*
- *Electrolyte liquid or fumes coming into contact with water will create vapors in the air from oxidization. These vapors may irritate skin and eyes. In the event of contact with vapors, rinse with plenty of water and consult a doctor immediately.*
- *Electrolyte fumes (when inhaled) can cause respiratory irritation and acute intoxication. Inhale fresh air and wash mouth with water. Consult a doctor immediately.*

Towing

In the event of an accident, the high voltage system must be disabled. The safety plug must be removed from the high voltage battery according to one of the methods described in sections of page 17-20 to disable the vehicle.

Towing Niro Vehicle is not different from towing a conventional FWD vehicle with the exception that all wheels needs to be lifted off the road. If emergency towing is necessary, we recommend having it done by an authorized Kia dealer or a commercial tow-truck service. Proper lifting and towing procedures are necessary to prevent damage to the vehicle. The use of wheel dollies or flatbed is recommended.

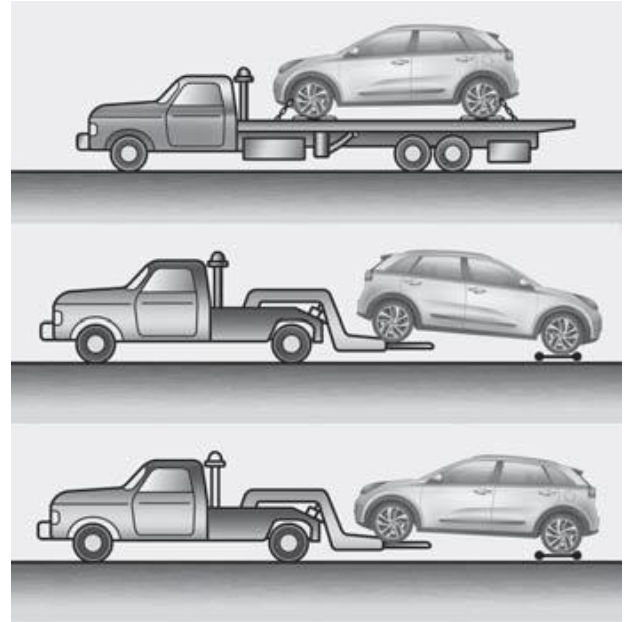

⚠ CAUTION

- *Do not tow the vehicle backwards with the front wheels on the ground as this may cause damage to the vehicle.*
- *Do not tow with sling-type equipment. Use wheel lift or flatbed equipment.*
- *Never tow the vehicle with the rear/front wheels on the ground (forward or backward), as this may cause fire or damage to the motor.*

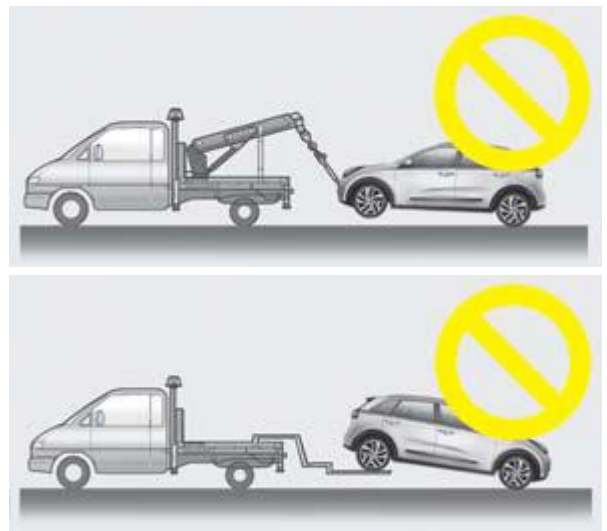

Emergency Starting

Before Jump Starting

1. If the vehicle appears to have a dead battery, first press the 12V Battery Reset button (A). Then immediately start the vehicle by pressing the brake and turning the ignition on or pressing the Engine Start/Stop button.
2. If the vehicle does not start after completing the above steps, then jump start the vehicle (as described below).



Jump Starting

Do not attempt to jump start the high voltage battery, it cannot be jump started. In case of full discharge of the high voltage battery, the vehicle must be towed as mentioned on the previous page. In case the 12V auxiliary battery is discharged, connect a starting device to the jump terminal in the engine room as you would any 12V battery (see image). Refer to "Emergency Starting" of Owner's Manual for additional information. Connect jumper cables in numerical order and disconnect in reverse order.



⚠ DANGER Electrocutation Risk

Do not attempt to jump start the Niro high voltage battery.